

**RoHS COMPLIANT**

**BILL OF MATERIALS**

Item	Description
1	USB A AOC (OD5.8 DCT)
2	USB C AOC (OD5.8 DCT)
3	A23-7186 OM2 cable, UL AWM 20276. 2 Channel / 50/125um, PVC <BLK> (OD=5.8mm) Min. Bend Radius = 40mm Storage Temp. = -20~70°C, Operating Temp. = 0~70°C
4	Label Printing on Cable

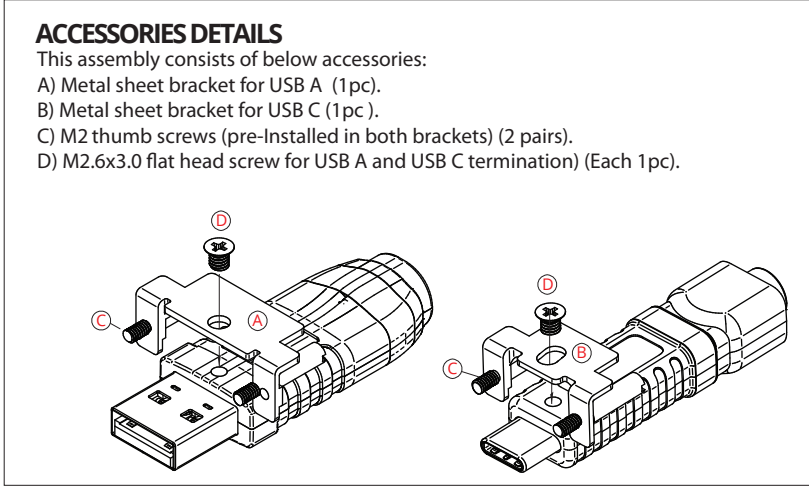

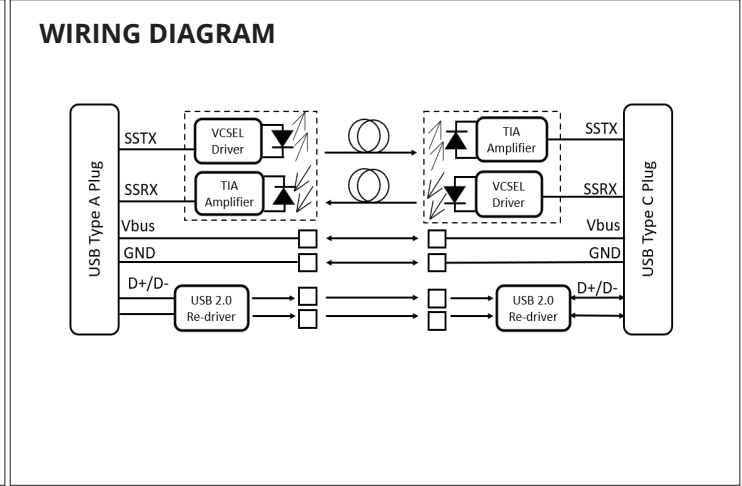

### Marking and Label Details

#### 1. DC Shell Laser Marking Details (Host Side - Botton)

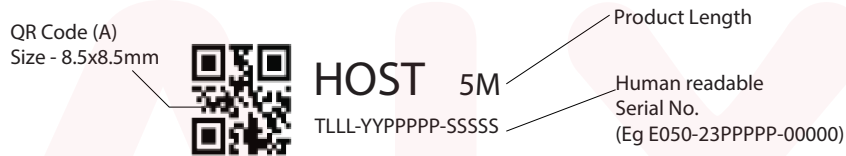

#### 2. Small Carton Box Label Details

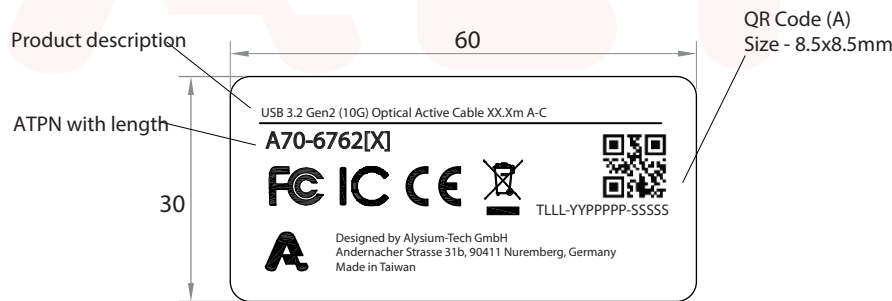

#### 3. Carton Box Shipping Label Details

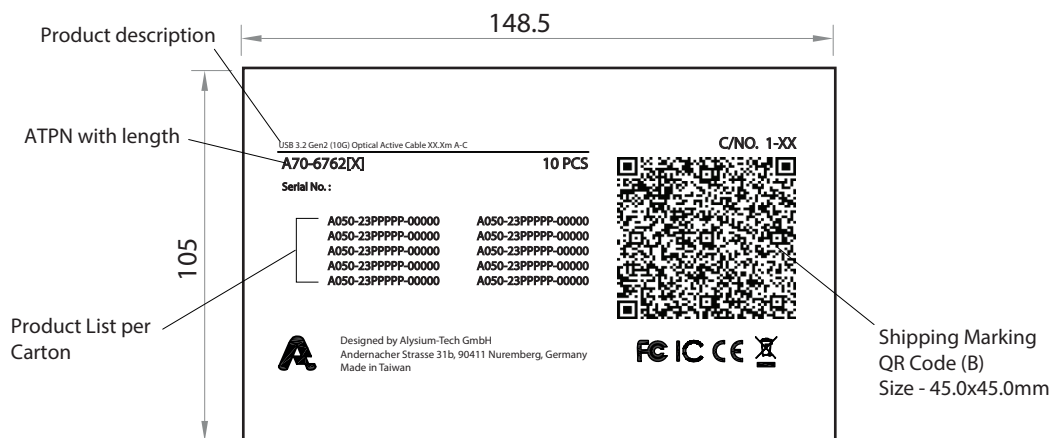

### Serial No. and QR Code (A) Details

#### 1. Serial No. Guide

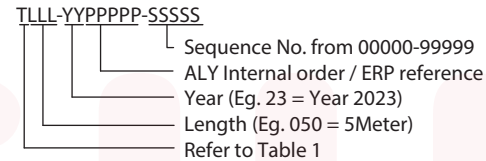

Note : Both QR Code (A) Content and human readable serial no. must be identical.

Table 1

ATPN	T Code
A70-6761	A
A70-6762	B
A70-5939	C
A70-5940	D
A70-6020	E
A70-6021	F

#### 2. Shipping Mark QR Code (B)

- Delimiter for the fields will be a semicolon (“;”)
- 1st field is the PO Number of ALYSIUM
- 2nd field will be the position number of the PO
- 3rd field is the product number of ALYSIUM
- 4th field is the number of products inside the outer box
- 5th field is for the serial numbers:
  - > Serial numbers are separated by hashtags (“#”)
  - > E.g. A050 23PPPPP 00000#A050 23PPPPP 00001#A050 23PPPPP 00002#A050 23PPPPP 00003#A050 23PPPPP 00004#A050 23PPPPP 00005#A050 23PPPPP 00006#A050 23PPPPP 00007#A050 23PPPPP 00008#A050 23PPPPP 00009
- 6th field (optional) is the number of the box for the whole shipment



## Parametric

### 1. Optical and Electrical Characteristics

Parameter	Min	Typ	Max	Unit
Optical wavelength		850		nm
Bit Rate		10		Gbps
Inter-pair skew SSTX/SSRX			10	ps
Intra-pair skew D+/D-			100	ps
Differential input/output impedance	76.5	90	103.5	Ω
Bit Error Rate @10Gbps			1x10 <sup>-12</sup>	
Supply voltage	4.45	5.0	5.2	V
Supply current			800	mA
Power consumption	0.4	0.5	0.6	W

## Production Test

### 1. Payload Test

#### Test Condition

- Host : ASMedia PCIe/USB 3.1 PHY
- Device : ASUS PCIe to USB 3.1 Gen2 Disk enclosure include Intel 660P M.2 PCIe SSD
- Test Tool : Windows CrystalDiskMark
- Pass Spec :
  - USB 3.2 : Read Speed > 700 MB/s, Write Speed > 650 MB/S
  - USB 2.0 : Read Speed > 25 MB/s, Write Speed > 20 MB/S
- Test Coverage : 100%

### 2. Bit Error Rate Test

#### Test Condition

- Center Frequency : 10000 MHz
- Compliance Test Pattern : PRBS23
- Signal Swing : 0.5 <= VALUE <= 0.8 V
- Pass Spec : BER < 10E-12
- Test Coverage : 2%

### 3. Photo Current Monitor

#### Test Condition

- Measure IC photo current monitor pin in BURN mode
- Test Tool : Multimeter
- Pass Spec : > 450 uA
- Test Coverage : 100%

### 4. Impedance Test

#### Test Condition

- Test channel : Vbus, GND, Super-Speed Channel
- Test Tool : Multimeter
- Pass Spec : 90 +/- 10 Ohm
- Test Coverage : 100%

### 5. FQC

#### Sampling plan

- ANSI ASQ Z1.4 , Inspection Level 1 , AQL 1.0

#### Test Condition

- Performance test (PC+ SSD)



## Product Placement

### 1. Product placement for small box size



④	USB 3.2 Gen2 AOC (A to C) synopsis	1 pcs
③	Kraft Paper Bag , 58*96mm	1 pcs
②	Hook and loop, black, 175*10mm	2 pcs
①	Locking Accessory. Type C Bracket x1, Thumb Screw x2, Countersunk Flat Screw x1 Type A Bracket x1, Thumb Screw x2, Countersunk Flat Screw x1	1 pcs
ITEM	SPECIFATION	QTY

### 2. Placement for small box label

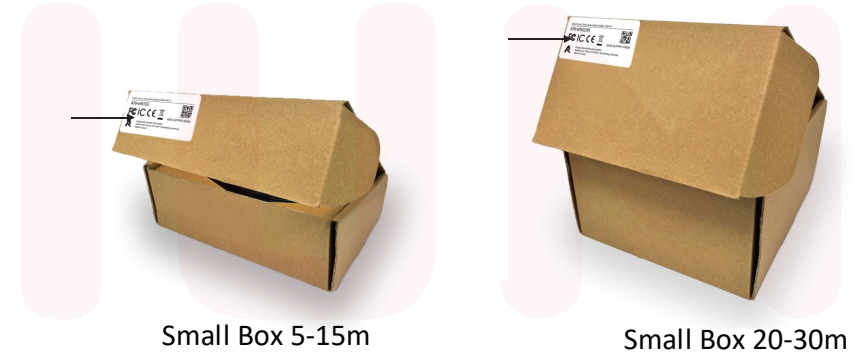

### 2. Placement for Carton box label (Shipping Mark)



Product Length (m)	Small Box Size (mm)	Carton Box size (mm)	Capacity per Carton (pcs)
5 - 15	210 x 189 x 67	390 x 350 x 230	10
20 - 30	210 x 189 x 112	390 x 350 x 230	6



# A79-4575 USB 3.2 Gen2 AOC Booklet

Stock availability starting from 2023



**ALYSIUM**  
 USB 3.2 Gen 2 Active Optical Cable



## BEDIENUNGSANLEITUNG

Folgen Sie der Reihenfolge dieser Bedienungsanleitung um sicherzustellen, dass Sie mit Hilfe ihrer optischen Verkabelung von ALYSIUM ihren Host erfolgreich mit dem Peripheriegerät verbinden.

- Überprüfen Sie, dass ihr Host und ihr Peripheriegerät kompatibel mit der Verkabelung sind. Optische Verkabelungen sind nur für die Benutzung im Innenbereich bestimmt, da die Stecker nicht wasserdicht sind.
- Stecken Sie die optische Verkabelung in den zugehörigen Port an ihrem Host und danach in das Peripheriegerät. Es sollte sich automatisch einschalten, sobald es ein Signal vom Host empfängt. Falls es sich nicht automatisch einschaltet, überprüfen Sie, dass die Stecker korrekt eingesteckt sind und alle auf dem Host installierten Gerätetreiber korrekt funktionieren.
- Denken Sie daran das Peripheriegerät über ihr Betriebssystem auszuwerfen, bevor sie die Verkabelung vom Host entfernen (soweit möglich).



- Eine vollständige Beschreibung der Produktspezifikation finden Sie auf: [www.allysium.com](http://www.allysium.com)
- Dieses Gerät entspricht den geltenden europäischen Richtlinien und Normen zur elektromagnetischen Verträglichkeit und elektrischen Sicherheit. Europäischer Vertreter siehe Rückseite.

Bestimmungsgemäße Verwendung: Die Verkabelung enthält keine Komponenten, die vom Benutzer repariert werden können. Achtung: Gefahr durch Laser.

Germany  
 Andensmacher Strasse 31b  
 90411 Nuremberg  
 T +49 (0) 911 93 78 78 0

USA  
 101 Montgomery Street, Suite 1500  
 San Francisco, CA 94104  
 T +1 415 248 7807

Malaysia  
 Oasis Square Ara Damansara  
 Ara Damansara PJU 1A  
 47301 Petaling Jaya  
 Selangor Malaysia  
 T +603 7832 6889

Canada  
 480 University Avenue  
 Suite 1500  
 Toronto, M5G 1V2, Ontario  
 T +1 416 598 7125

[sales@allysium.com](mailto:sales@allysium.com)  
[www.allysium.com](http://www.allysium.com)



## SETUP STEPS

Follow the setup steps in the order they are given to ensure that your Optical Cable by ALYSIUM correctly connects your host to your peripheral device.

- Ensure that your host and peripheral devices are compatible. Optical Cables by ALYSIUM are for indoor use only, as connectors are not water resistant.
- Insert the Optical Cable into the port on your host and then the device. The device should turn on automatically when it receives a signal from the host. If not, please make sure the connectors are securely connected and any software drivers installed on the host are working properly.
- When disconnecting the Optical Cable, remember to eject the device on your host before disconnecting the cable (where possible).



Intended Use: The product is connected between a USB host and a USB hub or between a USB hub and a USB device. No user intervention is required and the part contains no user-serviceable components. Caution - use of controls or adjustments or performance of procedures other than those specified herein may result in hazardous laser radiation exposure.

Be sure to install the product in the place where proper temperatures and humidity exist, otherwise parts of this product may be damaged.

Please consult updated specification sheet at: [www.allysium.com](http://www.allysium.com)

**IMPORTANT INFORMATION:** Please read all instructions, heed all warnings, and retain these instructions for future reference. This product is designed to use the power supply from its host and/or peripheral device. Therefore, the power consumption will be limited.

This product is a Class 1 laser product and complies with 21 CFR 1040.10 and 1040.11, except for deviations pursuant to Laser Notice No. 50, dated June 24, 2007. It complies with IEC 60825-1: (2014), FCC Part 15 Class B, and has been tested to IEC 60950-1.

Use of controls or adjustments or performance of procedures other than those specified herein may result in hazardous radiation exposure.

**IMPORTANT:** Connecting this product to a non-approved electrical source, operating above the recommended absolute maximum conditions may be considered an act of modifying or manufacturing a laser product. The person(s) performing such an act is required by law to recertify and reidentify the laser product under the provisions of U.S. 21 CFR.

**FCC STATEMENT OF COMPLIANCE:** This device complies with Part 15 of the FCC Rules. Operation is subject to the following two conditions: (1) this device may not cause harmful interference, and (2) this device must accept any interference received, including interference that may cause undesired operation.

**NOTE:** This equipment has been tested and found to comply with the limits for a Class B digital device, pursuant to Part 15 of the FCC Rules. These limits are designed to provide reasonable protection against harmful interference in a residential installation. This equipment uses and can radiate radio frequency energy and, if not installed and used in accordance with the instructions, may cause harmful interference to radio communications. However, there is no guarantee that interference will not occur in a particular installation. If this equipment does cause harmful interference to radio or television reception, which can be determined by turning the equipment off and on, the user is encouraged to try to correct the interference by one or more of the following measures:

- Reorient or relocate the receiving antenna or device
- Increase the separation between the equipment and receiver
- Connect the equipment into an outlet on a circuit different from that to which the receiver is connected
- Consult the dealer or an experienced radio/TV technician for help

**CANADIAN COMPLIANCE STATEMENT**  
 This device complies with Industry Canada license-exempt RSS standard(s). Operation is subject to the following two conditions: (1) this device may not cause interference, and (2) this device must accept any interference, including interference that may cause undesired operation of the device.

Complies with the Canadian ICES-003 Class B specifications. Cet appareil numérique de la classe B est conforme à la norme NMB-003 du Canada. This device complies with RSS 210 of Industry Canada.

**EUROPEAN UNION ONLY**  
 This apparatus is in conformance with the valid European directives and standards regarding electromagnetic compatibility and electrical safety.

European representative is:  
 ALYSIUM Tech GmbH  
 Andensmacher Strasse 31b  
 90411 Nuremberg, Germany

